

loopeal

## Elite toilet seat lifter

The most frustrating thing in life  
could be a filthy toilet seat

loopeal

Problems with touching the toilet seats?  
you are not alone..

..oh those 5h of life lost in pointless lifting  
of the toilet seat.



ONLY  
**\$69.99**

**ORDER NOW**

PayPal VISA MasterCard DISCOVER Fraud Protection Guaranteed

Available in Standard or Elongated sizes



The Easy

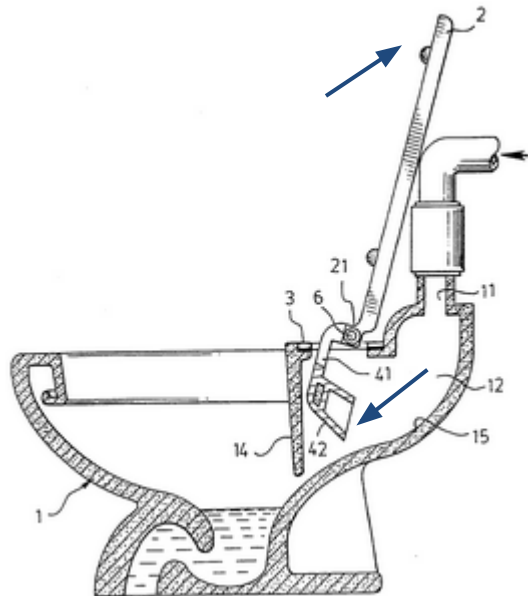

**390 £**

loopal

It all began with Denis who used to work in shopping centres

loopeal

My seat combines  
**soft close & delayed self lifting**  
without electricity or external fittings,  
It is still small (no counter-weight)  
and reasonably simple

# loopal

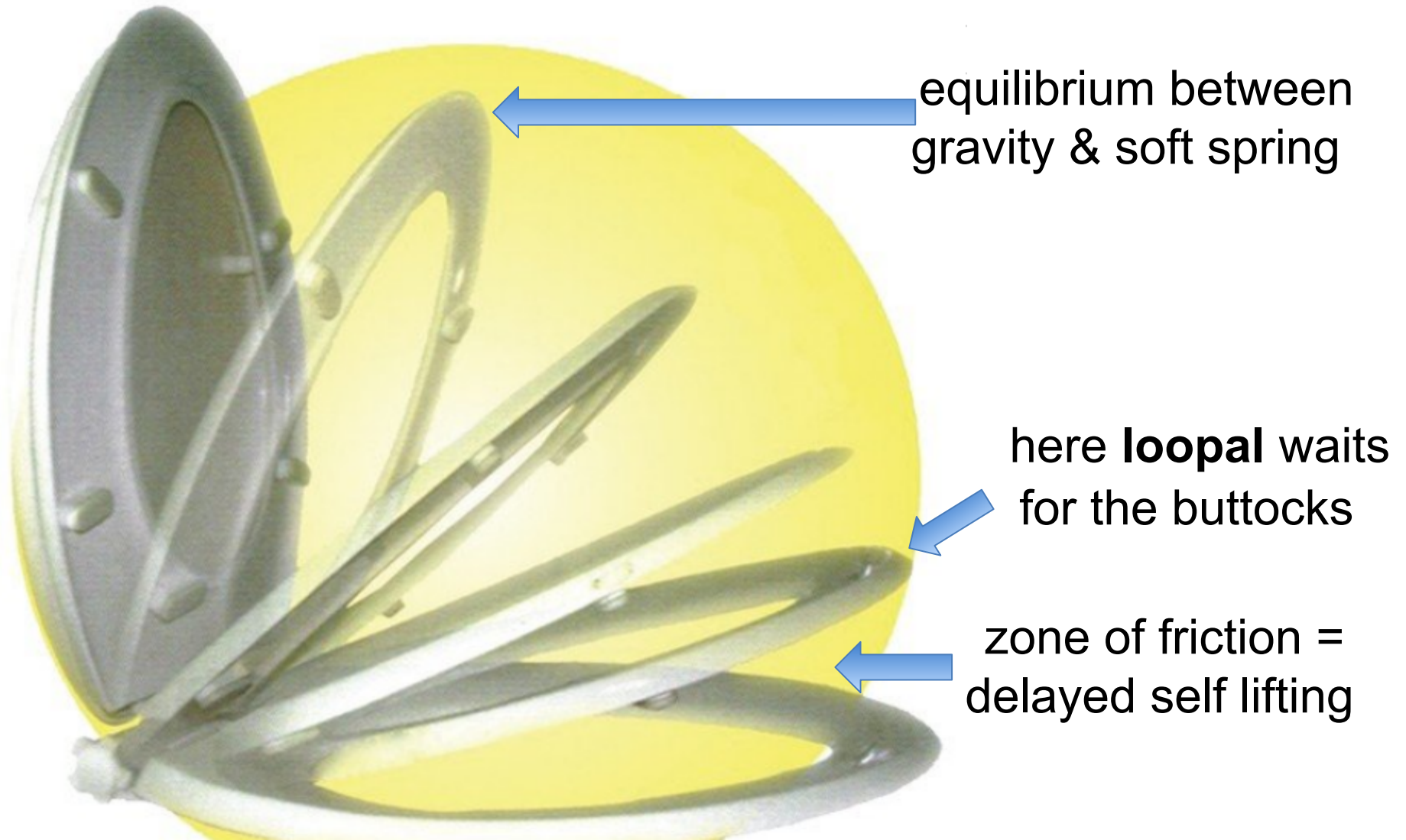

# loopal

Target audience:

Individual or family WC

Fewer silly rules:









# loopal

*Platforms:* - kickstarter - later amazon  
- contacts from BTA, A restroom A, WTO

*Social media and PR:*

- contact BTA, A restroom A, WTO
- awards [take part in 'loo of the year']
- stir discussion on toilet behaviour  
& urinary segregation

*Thanking you*

The logo for 'loopal' is presented in a 3D, blocky font. The letters are black with white highlights on their top and side surfaces, giving them a three-dimensional appearance. The word 'loopal' is written in a slightly upward-sloping perspective. A blue, thick, curved line is drawn around the letters, starting above the 'l', arching over the 'o's, and curving back down below the 'l', resembling a wide smile or a protective shield.

*loopal elevates toilet image !*

web: [loopal.weebly.com](http://loopal.weebly.com)

# loop pal

Two hinges

positioned  
on a slightly  
bended axis  
with

2 different torsion springs

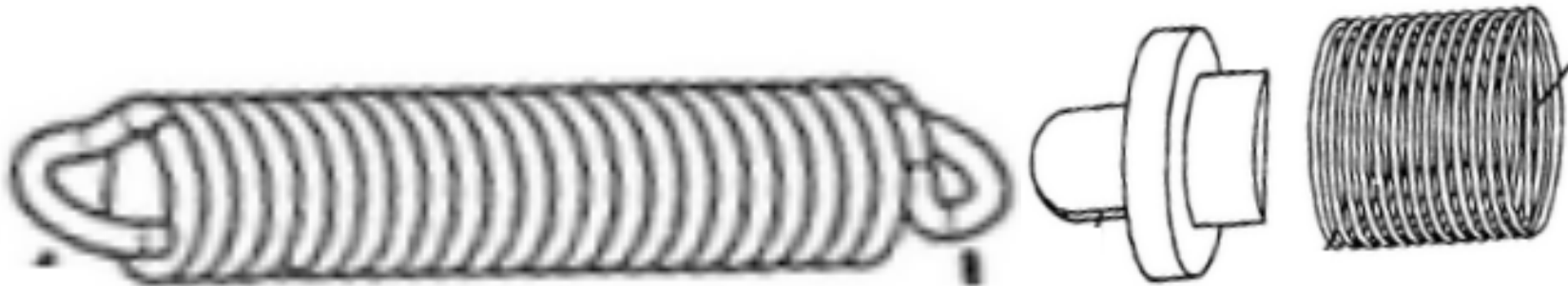
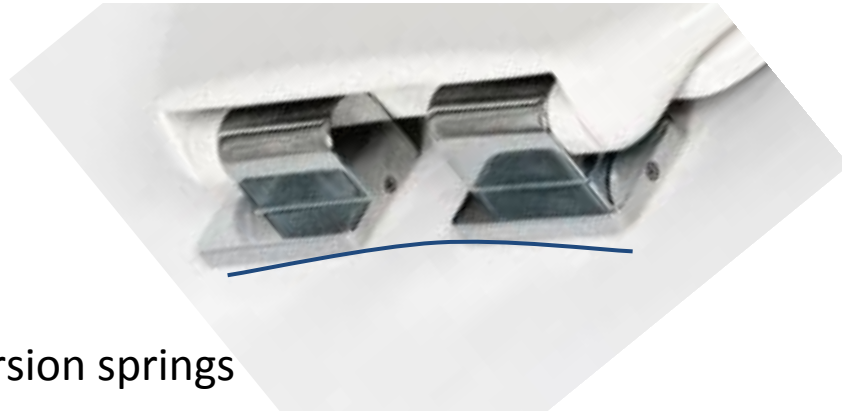

# loopal

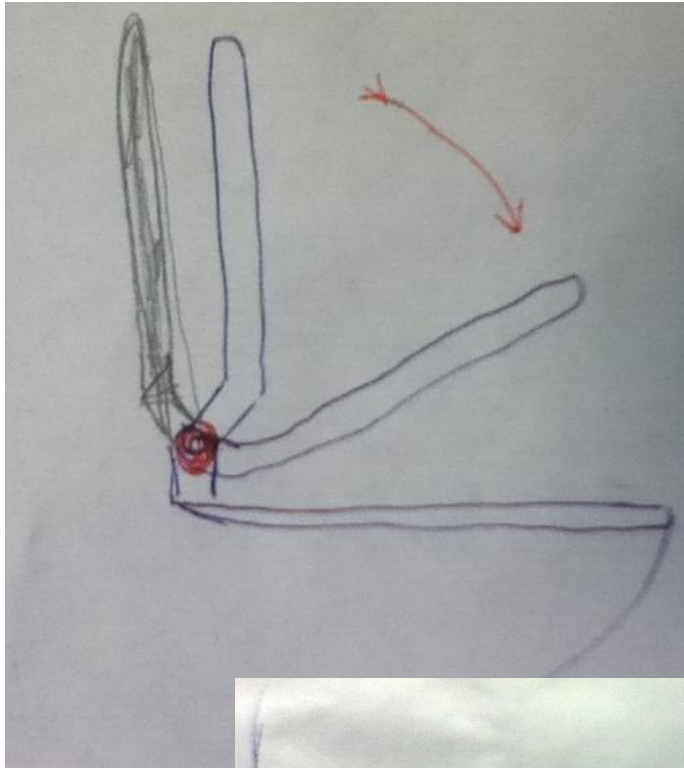

hinge:

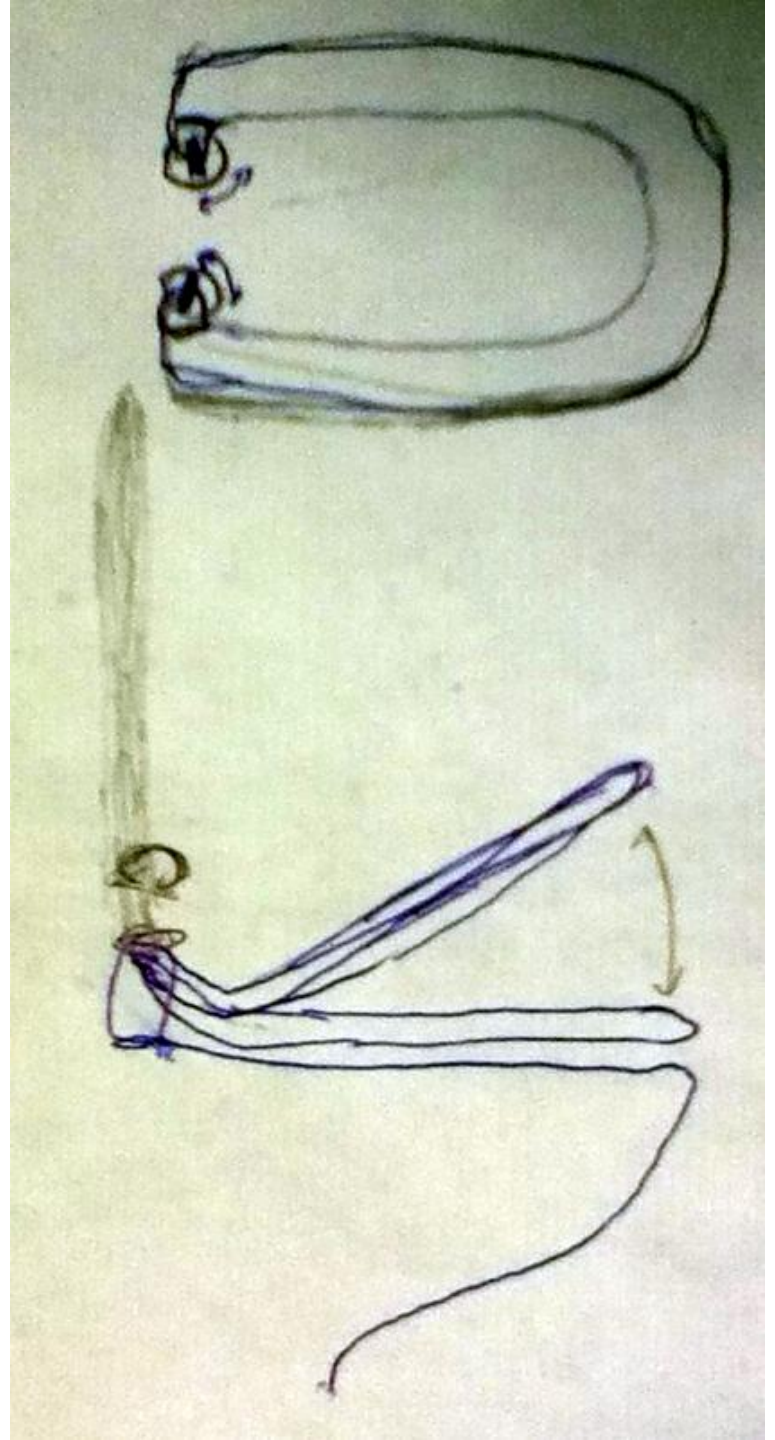
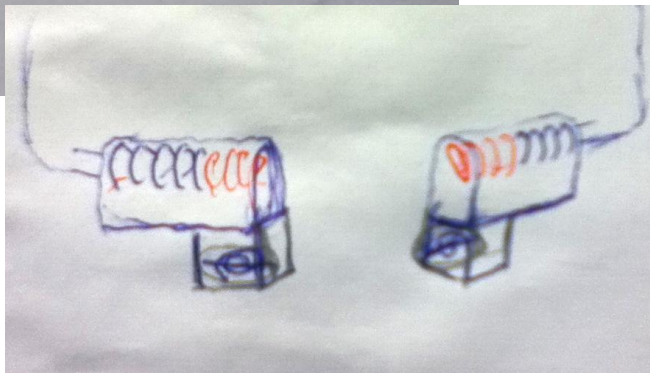

# loopyal

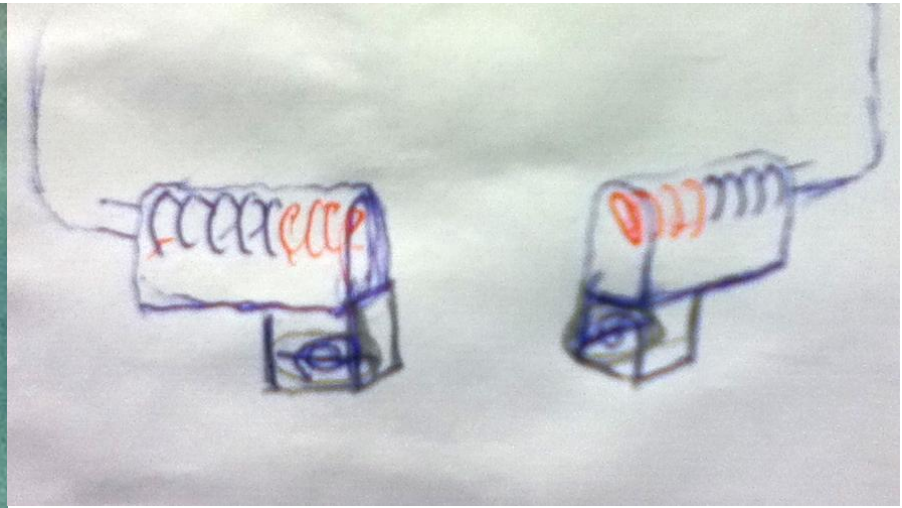
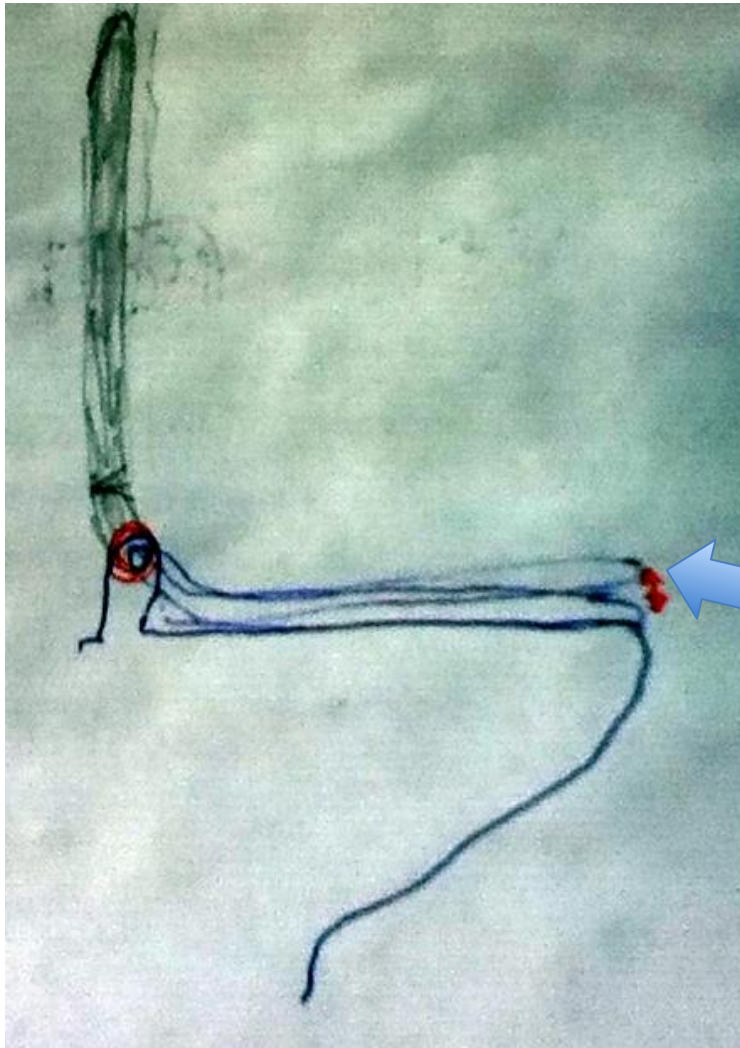

where the friction  
bended axis  
and delays